

## SIRMAN Aufschnittmaschine Mirra 220 C VERT

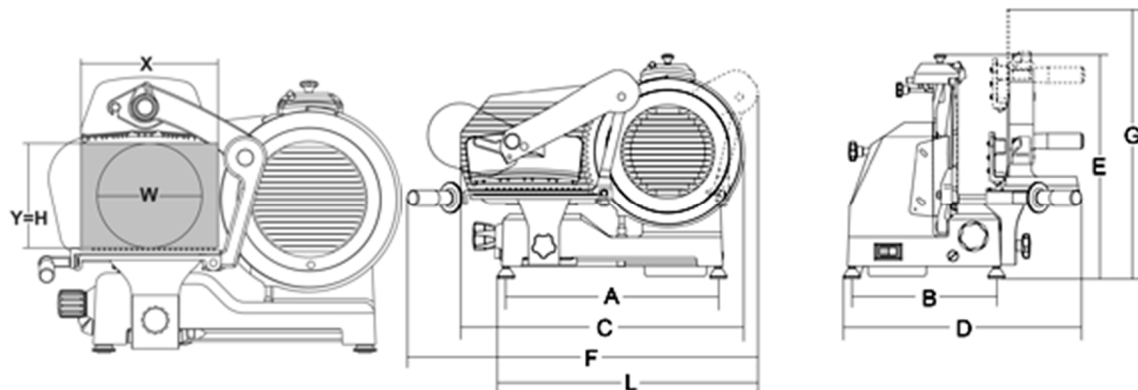

∅ Messer	mm 220 - inch. 9
Motor	Watt 147 – HP 0,20
Schnittbreite	mm 13
Wagenschub	mm 225
Wagen größe	mm 230x235
A	mm 400
B	mm 260
C	mm 500
D	mm 535
E	mm 400
F	mm 570
G	mm 405
L	mm 475
X	mm 205
Y	mm 150
H	mm 150
W	mm 150
Nettogewicht	kg 16,5